

KSL-H & KSL-Z

SLIT LAMP

INSTRUCTIONS FOR USE

Digital IFU supplement



Keeler
– A world without vision loss –

CONTENTS

1. INDICATIONS FOR USE	3
2. SAFETY.....	3
2.1 PHOTOTOXICITY	3
2.2 WARNINGS AND CAUTIONS	4
2.3 CONTRAINDICATION.....	5
3. CLEANING AND DISINFECTION INSTRUCTIONS.....	6
4. INSTALLATION OF DIGITAL UNIT	6
4.1 KSL-H SERIES SLIT LAMP.....	9
4.2 KSL-Z SERIES SLIT LAMP	9
5. CONTROLS.....	10
5.1 BACKGROUND ILLUMINATION ADJUSTMENT	10
5.2 EXPOSURE AND REVIEW BUTTONS.....	10
5.3 CAPTURE BUTTON.....	10
5.4 KEYBOARD SHORTCUTS	10
6. WARRANTY	11
7. SPECIFICATIONS AND ELECTRICAL RATINGS.....	11
7.1 ELECTROMAGNETIC EMISSIONS.....	11
7.2 ELECTROMAGNETIC IMMUNITY	12
7.3 RECOMMENDED SAFE DISTANCES	13
8. TECHNICAL SPECIFICATIONS.....	14
9. DIGITAL ACCESSORIES/SPARES	16
10. PACKAGING AND DISPOSAL INFORMATION.....	17

	Consult instructions for use		General warning sign
	Date of manufacture		Warning: Electricity
	Manufacturer's name and address		Warning: Floor level obstacle
	Country of manufacture		Warning: Non-ionizing radiation
	Waste Electrical and Electronic Equipment (WEEE) recycling		Warning: Optical radiation
	This way up		Warning: Hot surface
	Keep dry		Conformité Européene
	Fragile		Type B applied part
	Do not use if package is damaged		Class II equipment
	Temperature limit		Atmospheric pressure limitation
	Authorised representative in the European Community		Humidity limitation
	Use-by date		Serial number
	Catalogue number		Medical device
	Translation		

The Keeler Slit Lamp Digital IFU is designed and built in conformity with Directive 93/42/EEC, Regulation (EU) 2017/745 and ISO 13485 Medical Devices Quality Management Systems.

Classification: CE: Class I

FDA: Class II

The information contained within this manual must not be reproduced in whole or part without the manufacturer's prior written approval. As part of our policy for continued product development we the manufacturer reserve the right to make changes to specifications and other information contained in this document without prior notice.

This IFU is also available on the Keeler UK and Keeler USA websites.

Copyright © Keeler Limited 2021. Published in the UK 2021.

1. INDICATIONS FOR USE

This device is intended to be used only by suitably trained and authorised healthcare professionals.



CAUTION: Federal Law restricts this device to sale by or on the order of a physician or practitioner.

Intended use / purpose of instrument

The Keeler Slit Lamp facilitates an examination of the anterior segment, or frontal structures and posterior segment, of the human eye, which includes the eyelid, sclera, conjunctiva, iris, natural crystalline lens and cornea. The binocular slit-lamp provides stereoscopic magnified view of the eye structures in detail, enabling anatomical diagnoses to be made for a variety of eye conditions.

Brief description of the instrument

This Keeler Slit Lamp can either be mounted onto a custom table top supplied by Keeler or can be mounted on a third parties table top (refraction unit) by suitably trained technicians.

The Keeler Slit Lamp consists of 5 assemblies; illumination tower; observation system; XYZ translation base; chinrest assembly and a table top with power supply and accessory drawer.

The light intensity is controlled by a variable rheostat located on the XYZ translation base.

There are a number of selectable filters allowing the user to control the characteristics of the examination light.

2. SAFETY

2.1 PHOTOTOXICITY



CAUTION: The light emitted from this instrument is potentially hazardous.



The longer the duration of exposure, the greater the risk of ocular damage. Exposure to light from this instrument when operated at maximum intensity will exceed the safety guideline after 171 seconds for KSL-H and 81 seconds for KSL-Z.

While no acute optical radiation hazards have been identified for slit lamps, we recommend keeping the intensity of the light reaching the patient's retina to the minimum possible for the respective diagnosis. Children, people with aphakia and people suffering from eye conditions are most at risk. An increased risk may also occur if the retina is exposed to the same or a similar device with a visible light source within 24 hours. This applies, in particular, if the retina has been photographed with a flashbulb in advance.

Keeler Ltd shall on request, provide the user with a graph showing the relative spectral output of the instrument.

2.2 WARNINGS AND CAUTIONS

Please note that the proper and safe functioning of our instruments is only guaranteed if both the instruments and their accessories are exclusively from Keeler Ltd. The use of other accessories may result in increased electromagnetic emissions or reduced electromagnetic immunity of the device and may lead to incorrect operation.

Observe the following precautions in order to ensure safe operation of the instrument For the safety warning regarding the Keeler Slit Lamp please consult the Keeler Slit Lamp IFU.



WARNINGS

- Never use the instrument if visibly damaged and periodically inspect it for signs of damage or misuse.
- Check your Keeler product for signs of transport / storage damage prior to use.
- Do not use in the presence of flammable gases / liquids, or in an oxygen rich environment.
- US Federal Law restricts this device to sale by or on the order of a physician or practitioner.
- This device is intended to be used only by suitably trained and authorised healthcare professionals.
- This product should not be immersed in fluid.
- Repairs and modifications to the instrument must be made only by the specialized technicians of the manufacturer's Technical Service Centre or by personnel trained and authorised by the manufacturer. The manufacturer declines any and all responsibility for loss and/or damages resulting from unauthorised repairs; furthermore, any such actions will invalidate the warranty.
- The power switch and mains plug are the means of isolating the device from the mains supply - ensure both the power switch and mains plug are accessible at all times.
- Do not position the equipment so that is difficult to press the power switch or remove the mains plug from the wall socket.



- Route power cords safely to eliminate risk of tripping or damage to user.
- As the Digital Camera Assembly is medical equipment, special precautions are needed regarding EMC (electromagnetic compatibility)
- It is important that the Digital Camera Assembly is configured and installed/put into service, in accordance with the instructions/guidance provided herein and is used only in the configuration as supplied.



- Do not exceed maximum recommended exposure time.
- Should the instrument suffer shocks (for example, should it accidentally fall), and the optical system or the illumination system are damaged it may be necessary to return the instrument to the manufacturer for repair.

- Do not touch accessible connectors and the patient simultaneously.
- The owner of the instrument is responsible for training personnel in its correct use.
- Ensure the instrument or instrument table is placed on a level and stable surface.
- Use only genuine Keeler approved parts and accessories or device safety and performance may be compromised.
- Refraction stand variants or adaptors should only be used in combination with EN/IEC 60601-1 and EN/IEC 60601-1-2 compliant power supplies and devices.
- Shut down after every use. In case the dust cover is used: risk of overheating.
- For indoor use only (protect from moisture).
- Electrical equipment can be affected by electromagnetic interference, for example videostream may freeze for one minute or more. If this occurs whilst using this equipment, switch the unit off and reposition. Essential performance is determined as continuous videostream which cannot be interrupted for longer than one minute.
- Despite the testing of the Digital Camera Assembly that has been undertaken, normal operation of the Digital Camera Assembly can be affected by other electrical/electronic equipment and portable and mobile RF communications equipment.
- Keeler digital KSL is not intended to be used with wireless technology. Do not plug a wireless dongle into USB port. It is advisable to disable wireless technology on the computer to prevent unauthorised access to the camera.
- Keeler digital KSL cannot be used in the vicinity of sources known to cause electromagnetic disturbance (magnetic resonance imaging, computed tomography, radio-frequency identification, metal detectors, electronic article surveillance and other electromagnetic security systems). Do not bring the Keeler digital Slit lamp into magnetic resonance environment.
- The Digital Camera Assembly should not be used adjacent to or stacked with other equipment. If adjacent or stacked use with other equipment is necessary, the Digital Camera Assembly and the other equipment should be observed / monitored, to verify normal operation in the configuration in which it will be used.



Before use, the Slit Lamp should be allowed to adjust to the ambient room temperature for several hours. This is especially important when the unit has been stored or transported in a cold environment; this can cause severe condensation to develop on the optical elements.

2.3 CONTRAINDICATION

There is no restriction to patient population this device can be used with other than those outlined in the contra-indications stated below.

Slit lamps can produce discomfort in some photophobic patients due to the high illumination. Additionally patients must be co-operative and capable of sitting upright for the duration of the examination, therefore the technique may not be suitable for patients who are unable to sit upright for long periods of time or those with limited neck and back mobility.

3. CLEANING AND DISINFECTION INSTRUCTIONS



Before any cleaning of the instrument or the base unit, ensure the power lead is disconnected.

Only manual non-immersion cleaning as described should be used for this instrument. Do not autoclave or immerse in cleaning fluids. Always disconnect power supply from source before cleaning.

1. Wipe the external surface with a clean absorbent, non-shedding cloth dampened with de-ionised water / detergent solution (2% detergent by volume) or water / isopropyl alcohol solution (70% IPA by volume). Avoid optical surfaces.
2. Ensure that excess solution does not enter the instrument. Use caution to ensure cloth is not saturated with solution.
3. Surfaces must be carefully hand-dried using a clean non-shedding cloth.
4. Safely dispose of used cleaning materials.

4. INSTALLATION OF DIGITAL UNIT

For 'Digital Ready' variants of the Keeler Slit Lamp a Digital Camera Assembly (DCA) must be purchased separately, contact Keeler or your local distributor for details.

Set up the Slit Lamp as directed in the Instructions For Use (IFU) EP59-70040 or EP59-70043, contact your distributor if you are unable to locate a copy of these instructions.

1. Install the DCA carefully remove the eyepiece assembly from the magnification block by unscrewing the securing knob at the same time as supporting the eyepieces. The eyepieces assembly is a dovetail type fit to the magnification block.

Securing knob

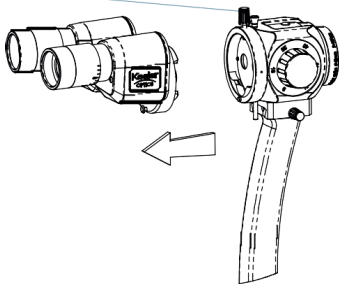

Care must be taken to avoid getting any dirt or dust on any of the optical components.

- Fit the DCA to the rear of the magnification block and tighten the securing knob to hold it in place.

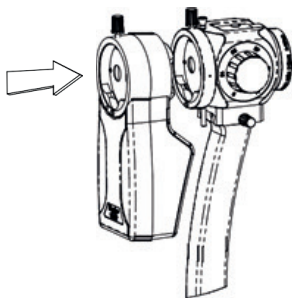

- Re-fit the eyepiece assembly to the rear of the DCA and secure it by tightening the securing knob.

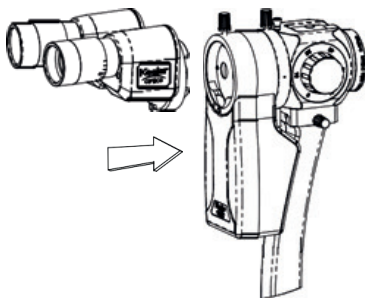

- Rotate the swing arm to either side of the unit, and with a suitable Philips screwdriver remove the cable channel cover plate.

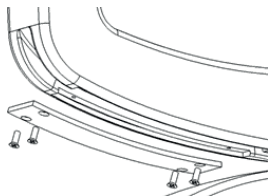

5. Remove the cover to the USB hub on the Slit Lamp base by undoing the small Phillips head screw and lifting off the cover.

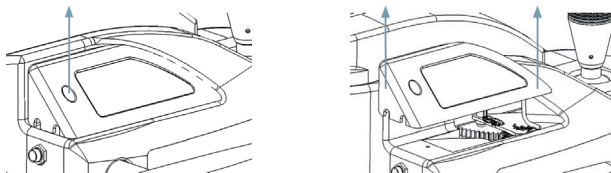

6. Connect the shorter USB cable (3020-P-7107) to the socket on the underside of the DCA and to the appropriate socket on the USB hub located on the Slit Lamp base. Ensure that there is plenty of slack at the USB hub end to allow Slit Arm rotation.

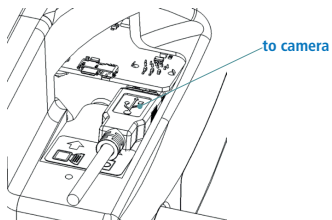

7. Route the cable in the groove in the Slit Lamp arm and replace the cover plate.

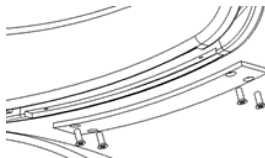

8. Connect the longer USB cable for connection to the PC to the hub and replace the USB hub cover plate, this secures the cables.

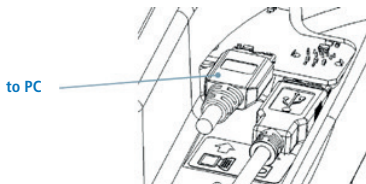

4.1 KSL-H SERIES SLIT LAMP

1. Clip the auxiliary diffuser and blue filter in place on the Slit Lamp tower upright posts, above the level of the mirror. Align the slot to the flattened post section.



2. Fit the background illumination fibre optic cable, The short end to the top of the lamp housing, the long end to the fibre optic swing arm adjacent to the mirror.

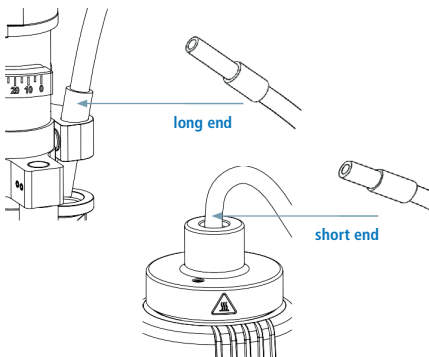

3. If CE compliant or FDA cleared imaging software has been installed, connect the PC USB cable to the PC.

4.2 KSL-Z SERIES SLIT LAMP

1. No fitting of the background light is required as the Slit Lamp comes fully assembled.

5. CONTROLS

5.1 BACKGROUND ILLUMINATION ADJUSTMENT

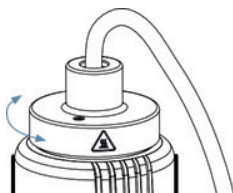

KSL-H SERIES SLIT LAMP

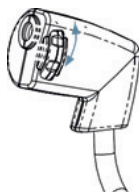

KSL-Z SERIES SLIT LAMP

5.2 EXPOSURE AND REVIEW BUTTONS

Pressing these buttons provides adjustment of the camera exposure.

- Increase exposure time (milliseconds)
- Review freeze frame images forwards
- Decrease exposure time (milliseconds)
- Review freeze frame images backwards



5.3 CAPTURE BUTTON

Press once to 'freeze frame'.

Use image review buttons to select best frame.

Press again to capture selected frame.



5.4 KEYBOARD SHORTCUTS

Press Ctrl + Alt + Shift with function keys			
F6	Right eye	F9	Review freeze frame images forwards
F7	Left eye	F10	Shorter exposure time
F8	Freeze frame / Trigger	F10	Review freeze frame images backwards
F9	Longer exposure time		

6. WARRANTY

The Keeler H-Series Slit Lamps are guaranteed for three years against faulty workmanship materials or factory assembly. Warranty is on a Return To Base (RTB) basis at the cost of the customer and may be void if the Slit Lamp has not been regularly serviced.

The manufacturer's warranty and terms and conditions are detailed on the Keeler UK website.

The mirror, main illumination lamp and general 'wear and tear' are excluded from our standard warranty.



The manufacturer declines any and all responsibility and warranty coverage should the instrument be tampered with in any manner or should routine maintenance be omitted or performed in manners not in accordance with these manufacturer's instructions.

There are no user serviceable parts in this instrument. Any servicing or repairs should only be carried out by Keeler Ltd. or by suitably trained and authorised distributors. Service manuals will be available to authorised Keeler service centres and Keeler trained service personnel.

7. SPECIFICATIONS AND ELECTRICAL RATINGS

The Keeler Slit Lamp is a medical electrical instrument. The instrument requires special care concerning electromagnetic compatibility (EMC). This Section describes its suitability in terms of electromagnetic compatibility of this instrument. When installing or using this instrument, please read carefully and observe what is described here.

Portable or mobile-type radio frequency communication units may have an adverse effect on this instrument, resulting in malfunctioning.

7.1 ELECTROMAGNETIC EMISSIONS

Guidance and manufacturer's declaration – electromagnetic emissions

The Digital Camera Assembly is intended for use in the electromagnetic environment specified below. The customer or user of the Digital Camera Assembly should ensure that it is used in such an environment.

Emissions test	Compliance	Electromagnetic environment – guidance
RF emissions CISPR 11	Group 1	The Keeler Slit Lamp uses RF energy only for its internal function. Therefore, its RF emissions are very low and are not likely to cause any interference in nearby electronic equipment.
RF emissions CISPR 11	Class B	The Digital Camera Assembly is suitable for use in a professional healthcare facility environment. The Digital Camera Assembly is not intended for use in home environment.
Harmonic emissions IEC 61000-3-2	Class B	

Emissions test	Compliance	Electromagnetic environment – guidance
Voltage fluctuations / flicker emissions IEC 61000-3-3	Complies	

7.2 ELECTROMAGNETIC IMMUNITY

Guidance and manufacturer's declaration – electromagnetic immunity

The Digital Camera Assembly is intended for use in the electromagnetic environment specified below. The customer or user of the Digital Camera Assembly should ensure that it is used in such an environment

Immunity test	IEC 60601 Test level	Compliance level	Electromagnetic environment – guidance
Electrostatic discharge (ESD). IEC 61000-4-2	± 8 kV contact ± 15 kV air	± 8 kV contact ± 15 kV air	Floors should be wood, concrete or ceramic tile. If floors are covered with synthetic material, the relative humidity should be at least 30%.
Electrical fast transient/burst. IEC 61000-4-4	± 2 kV for power supply lines ± 1 kV for power supply lines	N/A N/A	Mains power quality should be that of a typical professional healthcare facility environment.
Surge. IEC 61000-4-5	± 1 kV line(s) to line(s) ± 2 kV line(s) for input/output line(s)	N/A N/A	Mains power quality should be that of a typical professional healthcare facility environment.
Voltage dips, short interruptions and voltage variations on power supply input lines. IEC 61000-4-11	$U_T = 0\%$ 0.5 cycle (0, 45, 90, 135, 180, 225, 270, 315°) $U_T = 0\%$; 1 cycle $U_T = 70\%$; 25/30 cycles (@ 0°) $U_T = 0\%$; 250/300 cycle	$U_T = 0\%$ 0.5 cycle (0, 45, 90, 135, 180, 225, 270, 315°) $U_T = 0\%$; 1 cycle $U_T = 70\%$; 25/30 cycles (@ 0°) $U_T = 0\%$; 250/300 cycle	Mains power quality should be that of a typical professional healthcare facility environment. If the user of the Digital Camera Assembly requires continued operations during power mains interruptions, it is recommended that the Digital Camera Assembly be powered from an uninterruptible power supply.
Power frequency (50/60 Hz) magnetic field. IEC 61000-4-8	30 A/m	30 A/m	Power frequency magnetic fields should be at a level characteristic of a typical location in a typical professional healthcare facility environment.

Note: U_T is the a. c. mains voltage prior to application of the test level.

Immunity test	IEC 60601 Test level	Compliance level	Electromagnetic environment – guidance
			Portable and mobile RF communications equipment should be used no closer to any part of the Digital Camera Assembly, including cables, than the recommended separation distances calculated from the equation applicable to the frequency of the transmitter.
		Recommended separation distance	
Conducted RF IEC 61000-4-6	6 Vrms 150kHz to 80MHz	6 V	$d = 1.2 \sqrt{p}$
Radiated RF IEC 61000-4-3	10 V/m 80MHz to 2.7GHz	10 V/m	$d = 1.2 \sqrt{p}$ 80MHz to 800 MHz $d = 2.3 \sqrt{p}$ 800MHz to 2.7GHz
			<p>Where p is the maximum output power rating of the transmitter in watts (W) according to the transmitter manufacturer and d is the recommended separation distance in metres (m).</p> <p>Field strengths from fixed RF transmitters, as determined by an electromagnetic site survey¹, should be less than the compliance level in each frequency range.²</p> <p> Interference may occur in the vicinity of equipment marked with this symbol.</p>

Note: At 80MHz and 800MHz, the higher frequency range applies. These guide lines may not apply in all situations.

Electromagnetic propagation is affected by absorption and reflection from structures, objects and people.

1 Field strengths from fixed transmitters, such as base stations (cellular / cordless) telephones and land mobile radios, amateur radio, AM and FM radio broadcast and TV broadcast cannot be predicted theoretically with accuracy. To assess the electromagnetic environment due to fixed RF transmitters, an electromagnetic site survey should be considered. If the measured field strength in the location in which the Keeler Slit Lamp is used exceeds the applicable RF compliance level above, the Keeler Slit Lamp should be observed to verify normal operation. If abnormal performance is observed, additional measures may be necessary, such as re-orientating or relocating the Keeler Slit Lamp.

2 Over the frequency range 150kHz to 80 MHz, field strengths should be less than 10 V/m.

7.3 RECOMMENDED SAFE DISTANCES

Recommended separation distances between portable and mobile RF communications equipment and the Digital Camera Assembly

The Digital Camera Assembly is intended for the use in an electromagnetic environment in which radiated RF disturbances are controlled. The customer or the user of the Digital Camera Assembly can help prevent electromagnetic interference by maintaining a minimum distance between portable and mobile RF communications equipment (transmitters) and the Digital

Camera Assembly as recommended below, according to the maximum output power of the communications equipment.

Rated maximum output power of transmitter (W)	Separation distance according to frequency of transmitter (m)		
	150 kHz to 80MHz $d = 1.2\sqrt{p}$	80MHz to 800MHz $d = 1.2\sqrt{p}$	800MHz to 2.7GHz $d = 2.3\sqrt{p}$
0.01	0.12	0.12	0.23
0.1	0.38	0.38	0.73
1	1.2	1.2	2.3
10	3.8	3.8	7.3
100	12	12	23

For transmitters rated at a maximum output power not listed above, the recommended separation distance in metres (m) can be determined using the equation applicable to the frequency of the transmitter, where p is the maximum output power rating of the transmitter in watts (W) according to the transmitter manufacturer.

Note: At 80MHz and 800MHz, the separation distance for the higher frequency applies.

These guidelines may not apply in all situations. Electromagnetic propagation is affected by absorption and reflection from structures, objects and people.

8. TECHNICAL SPECIFICATIONS

Digital System Camera

Camera	Resolution 2048 x 1536
	Pixel Class: 3 MPixel
	Sensor size: 1/1.8"
	Sensor Technology: CMOS COLOR
PC Specification	PC compliant with Electrical Safety (Medical) EN/IEC 60601-1
	CPU: i5, 8/256GB SSD
	Memory: 8GB RAM or higher
	2 USB slots must be available, USB port: 3.0 or higher which will provide power to the camera (5V and up to 1A) and receive the video data.
	Hard disk speed 5200 rpm or higher
	Operating system: Microsoft Windows 10 Pro
	Windows 10 Pro Recommended screen resolution: 1920 x 1200 pixels
Software requirements	CE compliant or FDA cleared camera imaging software

Weight, packed (approx.)

Digital Slit Lamp complete	20.0Kg, 75 x 54 x 45cm W x D x H
-----------------------------------	----------------------------------

Protection against ingress IPxO

Class II ME equipment

Insulation between mains parts and the functional earth provide at least two means of protection.

Power Supply

Power supply unit	Switch mode, (100V-240V input) +/- 10% multi plug compliant to EN/IEC 60601-1 EN/IEC 61000-6-2, EN/IEC 61000-6-3
Fuse	T2.5AH, 250V
Power supply output	12V DC: 2.5 amps must be EN/IEC 60601 compliant
Complies with	Electrical Safety (Medical) EN/IEC 60601-1 Electromagnetic compatibility EN/IEC 60601-1-2 Ophthalmic instruments - Fundamental requirements and test methods ISO 15004-1 Ophthalmic instruments - Optical radiation hazard ISO 15004-2

Fuse ratings and quantity

2.5 amp anti-surge

Fuse current 2.5A

Voltage rating V AC 250V



Breaking capacity 1500Amps



Blow characteristic: Time Delay

If the Digital camera Assembly is used with power supplies or cables other than those supplied, this may result in increased emissions or decreased immunity of the Digital Camera Assembly in relation to EMC performance.

It should be noted that neither the power supply nor the cables provided with the Digital Camera Assembly should be used on other equipment. To do so may result in increased emissions or decreased immunity of the other equipment in relation to EMC performance.

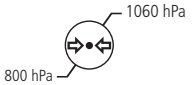
Environmental Conditions:

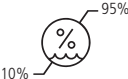
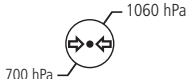
USE	
	
	
Shock (without packing)	10 g, duration 6 ms

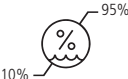
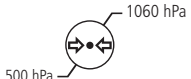
USE		
STORAGE CONDITIONS		
		
TRANSPORT CONDITIONS		
		
Vibration, sinusoidal	10 Hz to 500 Hz: 0.5g	
Shock	30 g, duration 6 ms	
Bump	10 g, duration 6 ms	

*This instrument does not meet the temperature requirements of ISO 15004-1 for storage and transportation. Do not store or transport this instrument in conditions where the temperature may rise above 50 °C.

9. DIGITAL ACCESSORIES/SPARES

Item	Part Number	Description
Kapture Imaging Software Licence	3020-P-7036	Software is on a USB stick
Keeler Connect Software Licence	3020-P-7112	USB Key
Large P Table (1120mm x 590mm)	3020-P-7138	For Digital Ready KSL's only
Large Rectangle Table (1000mm x 400mm)	3020-P-7128	
Table Leg – Offset	3020-P-7085	For use with large table options.
USB Cable camera to hub	3020-P-7107	
USB cable hub to PC	3020-P-7029	
External illuminator, H-series	3020-P-5039	
Auxiliary diffuser, H-series	3020-P-7034	
Auxiliary blue filter, H-series	3020-P-7035	

10. PACKAGING AND DISPOSAL INFORMATION

Disposal of old electrical and electronic equipment



This symbol on the product or on its packaging and instructions indicates that this product shall not be treated as household waste.

To reduce the environmental impact of WEEE (Waste Electrical Electronic Equipment) and minimise the volume of WEEE entering landfills we encourage at product end of life that this equipment is recycled and reused.

If you need more information on the collection reuse and recycling then please contact B2B Compliance on 01691 676124 (+44 1691 676124). (UK only).

Any serious incident that has occurred in relation to the device must be reported to the manufacturer and the competent authority of your Member State.

Contact



Manufacturer

Keeler Limited
Clewer Hill Road
Windsor
Berkshire
SL4 4AA UK

Freephone 0800 521251

Tel +44 (0) 1753 857177

Fax +44 (0) 1753 827145

USA Sales Office

Keeler USA
3222 Phoenixville Pike
Building #50
Malvern, PA 19355 USA
Toll Free 1 800 523 5620
Tel 1 610 353 4350
Fax 1 610 353 7814

China Office

Halma China Group
名称：沃迈（上海）机电有限公司
地址：上海市闵行区金都路1165弄
123号23幢一号厂房三层B座
电话：021-6151 9025

India Office

Keeler India
Halma India Pvt. Ltd.
Plot No. A0147, Road No. 24
Wagle Industrial Estate
Thane West – 400604, Maharashtra
INDIA
Tel +91 22 4124 8001



Visiometrics, S. L., Vinyals, 131
08221 Terrassa, Spain

EP59-70041 Issue 12

Date of Issue 12/05/2021



Keeler
– A world without vision loss –